

Architectural Accents

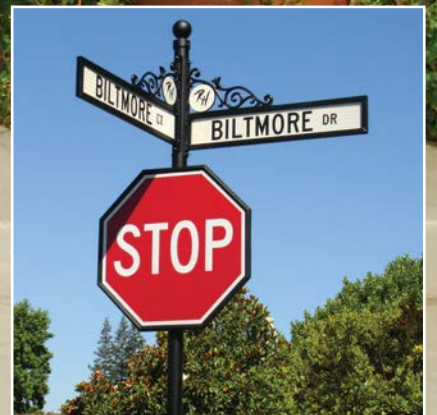

Kutstone Composite Site & Patio Amenities



KUTSTONE™ COMPOSITE SITE & PATIO AMENITIES

- Made with real crushed stone, blended with high quality resin and reinforced with fiberglass for extra strength.
- Looks and feels like real stone, color throughout material.
- More economical than real stone pieces, comparable in price to concrete.
- Lightweight: easier handling, less installation labor, cheaper shipping.
- Fill with soil, sand, rock or concrete to add weight and provide a solid foundation.
- Sealed with UV resistant matte sealant.

Products:

A. Roman Bowl Planters (sizes: 24", 30", 36", 46")

B. Roman Scupper Bowls (sizes: 24", 30", 36")*

C. Roman Urn Planters (sizes: 18", 22", 28", 34", 44")

D. Planter Saucers (sizes: 15", 19", 23", 26", 36")

* Easy to drill and add plumbing (not included).



Stone texture



Lightweight

Kutstone™ Finishes:



Tan



Sandstone



Autumn Leaf



Speckled Granite

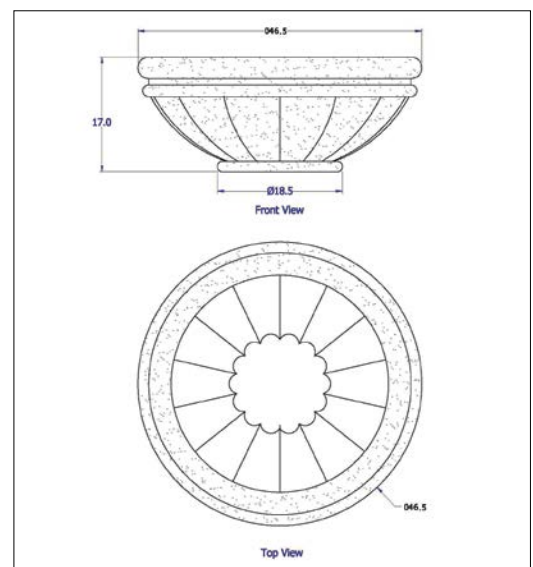

Architectural drawings are available on our website.

Made With Real Crushed Stone



Kutstone Composite Site & Patio Amenities



KUTSTONE™ COMPOSITE SITE & PATIO AMENITIES

- Made with real crushed stone, blended with high quality resin and reinforced with fiberglass for extra strength.
- Looks and feels like real stone, color throughout material.
- More economical than real stone pieces, comparable in price to concrete.
- Lightweight: easier handling, less installation labor, cheaper shipping.
- Fill with soil, sand, rock or concrete to add weight and provide a solid foundation.
- Sealed with UV resistant matte sealant.

Products:

- A. Saratoga Planters (set of three)(heights: 27.6", 22.8", 17.7")
- B. Cubic Planters (sizes: 24", 30", 36", 42")
- C. Cubic Fountains/Scuppers (sizes: 24", 30", 36", 42")*
- D. Melbourne Planters (sizes: 17", 24", 34")
- E. Trash Ring for 34" Urn (urn holds 30 gallon garbage can)
- F. 22" Trash Can with Lid

* Easy to drill and add plumbing (not included).



Stone texture



Lightweight

Kutstone™ Finishes:



Tan



Sandstone



Autumn Leaf



Speckled Granite



Looks & Feels Like Real Stone

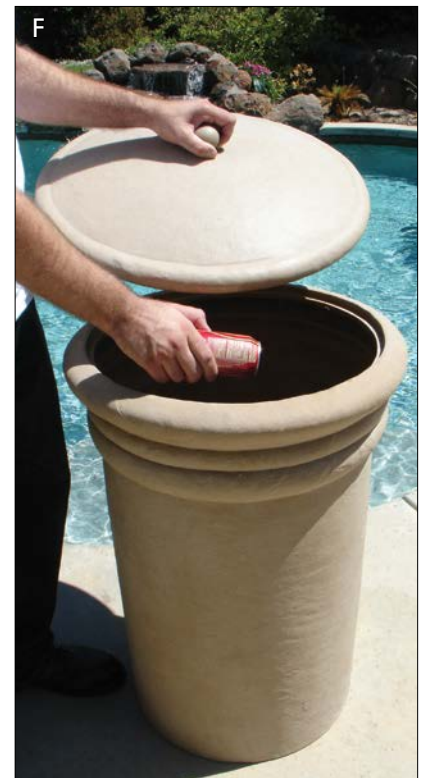
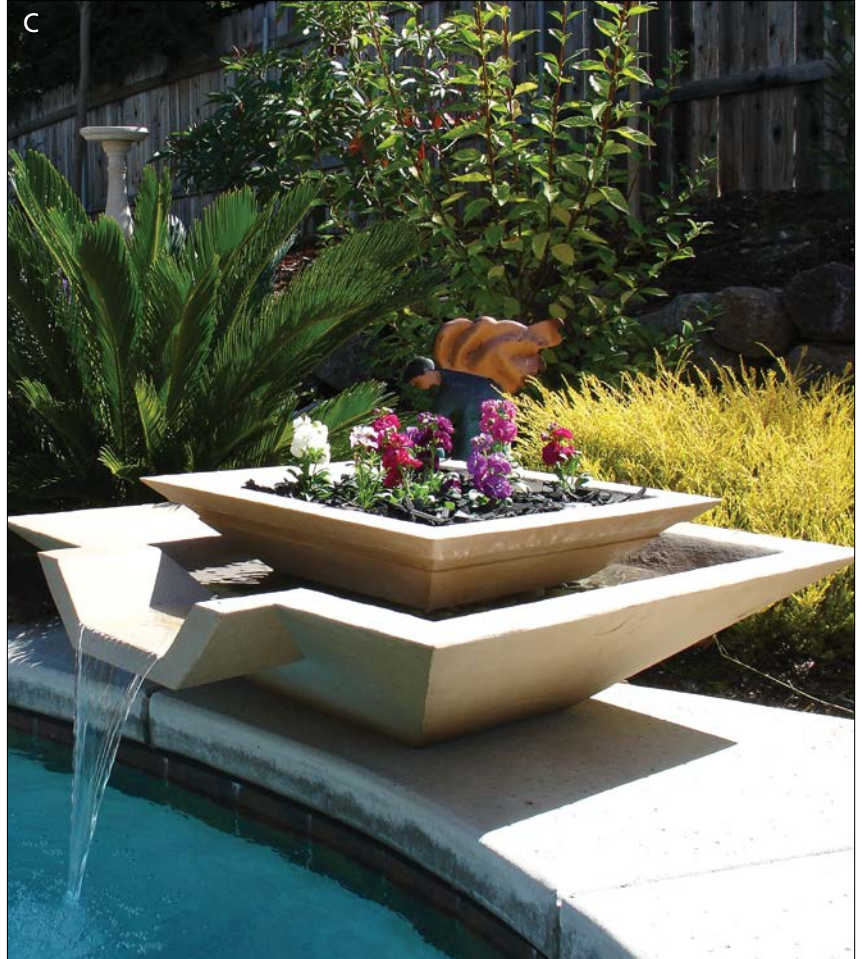

Decorative Faucet Posts



DECORATIVE FAUCET POSTS

- Decorative aluminum post with standard faucet.
- Powder coat finish in black or bronze.
- Pre-plumbed with permanent plumbing or garden hose adapter.
- Optional solid brass faucet.
- Optional scroll hose holder holds up to 50 feet of hose (available separately).

Products:

- A. Faucet Post: Shown with Scroll Hose Holder, Ornate base and Pineapple finial. (FPST-703-HHLD)
- B. Faucet Post: Shown with Fluted base and Ball finial. (FPST-804)
- C. Faucet Post: Shown with Fluted base and Large Horsehead finial. (FPST-801)

DECORATIVE POSTS WITH SCROLL ARMS

- Mix and match a custom post: select a finial or solar lamp, base, one or two scroll arms, faucet, hose holder, and address plaque.
- Scroll arms are ready for your hanging baskets.
- Decorative aluminum post with powder coat finish.
- Standard height 6 feet (taller models available).
- Scroll arm length 23-1/2".
- Permanent direct burial mount only.

Products:

- D. Decorative Post: Shown with Scroll Hose Holder, two Scroll Arms, Ornate base, and Pineapple finial. (DPSA-CUSTOM)
- E. Decorative Post: Shown with Hanging Address Plaque, two Scroll Arms, and Large Horsehead finial. (DPSA-CUSTOM)



Plumbing Options

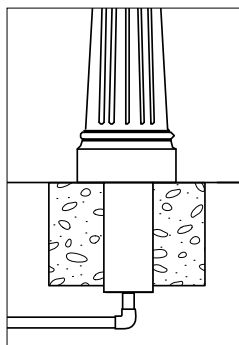

Permanent PVC plumbing.

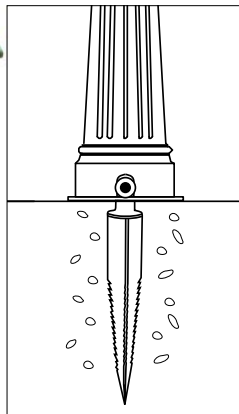

Ground spike mount with garden hose adapter.

Finial Options



#1: Large Horsehead



#3: Pineapple



#4: Ball

Base Options



#7: Ornate



#8: Fluted

Bayview Solar Lamp



Post Color Options



Bronze



Black

Scroll Hose Holder



Scroll Hose Holder available separately.

Yard, Ranch & Golf Signs

YARD, RANCH & GOLF SIGNS

Finally, professional grade decorative address and golf signage at a reasonable price. Our custom signage can be matched community wide: address plaques, street signs, course markers, club house signs and community entrance signs. These individually hand cast aluminum signs reflect traditional good taste. Each has deep cast figures and design motifs that are finished in all-weather baked enamel. Posts are cast aluminum and feature a powder coat finish. Need a custom design that prominently features your community's logo? We will help you select the mailbox and signage options that will maximize your community's curb appeal.

Products:

- A. Scroll Mount Address Post: Shown with Ornate base and Pineapple finial. Plaque 13" x 6" (4" #'s). Scroll 16" x 14". Pole height 4' 6". (ADPST-703)
- B. Large Hanging Ranch Sign: Shown with Ornate base and Ball finial. Sign 15-1/2" x 10-1/4". Pole height 5' 4". Scroll Arm 23-1/2" x 10". (SNPST-704)
- C. Arch Golf Marker: Shown with Fluted base and Ball finial. 60" tall. Custom sizes and shapes available. (GLFPST-804-ARCH)
- D. Scroll Mount Address Post: Shown with Fluted base and Bayview Solar Lamp. Lamp features beveled glass panes with super-bright LEDs. Plaque 13" x 6" (4" #'s). Scroll 16" x 14". Pole height 5'. (ADPST-800-SL)
- E. Double Sided Hanging Barn Sign with Scroll Arm: Sign 15-1/2" x 10-1/4". Overall 23-1/2" x 21-1/2" x 2". (BRNSGN-TSP1)

Post Color Options

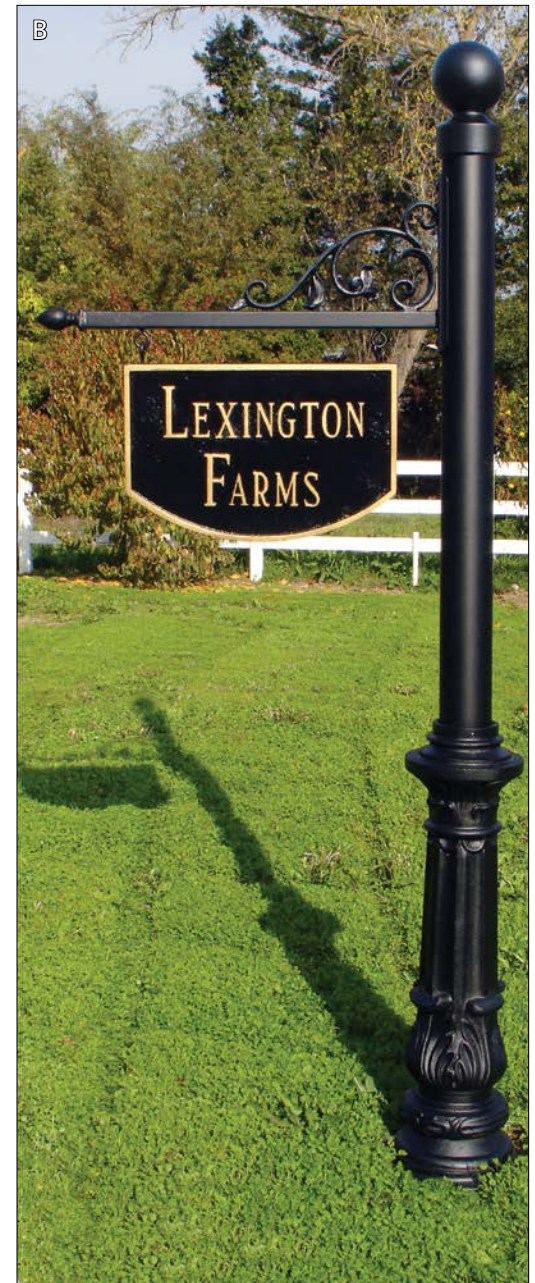
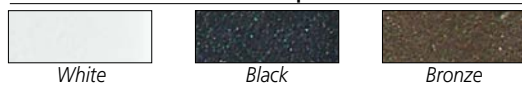

Estateview Stucco CBU Mailbox Center



ESTATEVIEW STUCCO CBU MAILBOX CENTER

Our decorative stucco column transforms a Cluster Box Unit (CBU) into an elegant mail center. This attractive, prefabricated column comes ready-to-install over a standard USPS approved CBU mailbox and pedestal*. Each column is 42" wide x 30" deep x 72" high.

The column has an easy-to-handle styrofoam core with a ready-to-paint, exterior-grade stucco surface. As an option, we offer three paint choices: Sandstone, Burnt Tuscan, or Slate Gray (custom colors available). Two coating options are available.

Standard Single Coat: This is the finish included in the base price. It can be painted with any exterior-grade paint.

Extra Durable Double Coat: The second layer of cement is thicker and stronger than the standard single coat and is better suited for high-traffic locations where there is a greater chance of surface impacts.

Our USPS approved CBUs offer centralized mail delivery with greatly enhanced security. They are designed to meet or exceed the newest USPS standards. Every CBU has an outgoing mail compartment and parcel locker. Our CBUs are made of rust and rot proof aluminum and stainless steel. CBUs are available in 8, 12, 13, and 16 door units. CBU color options include: black, bronze, sandstone, white, and green.

Products:

- A. 8 Patron Box, Type I (CBU-8-EVMC-TALL)
- B. 12 Patron Box, Type II (CBU-12-EVMC-TALL)
- C. 13 Patron Box, Type IV (CBU-13-EVMC-SHRT)
- D. 16 Patron Box, Type III (CBU-16-EVMC-SHRT)
- E. Bayview Solar Lamp: Features beveled glass panes, super-bright LEDs, 8-1/2" x 19" (LMC-800-SL)

* Local USPS approval recommended for stucco column. Your pad must be level (without slope) for a smooth installation.

Stucco Color Options

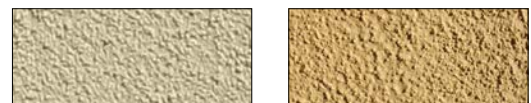

Sandstone

Burnt Tuscan

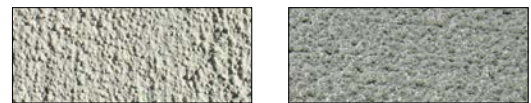

Slate Gray

Unpainted

CBU Color Options



White

Forest Green

Sandstone

Black

Dark Bronze



Parkview Stucco CBU Cap & Pedestal

PARKVIEW STUCCO CBU CAP & PEDESTAL

Builders, architects and developers have long been asking for an attractive cluster mailbox. Our Stucco Cap and Pedestal fills this need by converting a standard USPS CBU mailbox unit into an elegant mail center. Featuring an exterior-grade stucco surface that is painted to match the CBU, our Cap and Pedestal will add "curb appeal" to any residential or commercial development. Some existing CBUs can be upgraded by purchasing the Cap and Pedestal separately. Available in sandstone, black or bronze (white and green special order).

Products:

- A. Parkview Cap and Pedestal for 8 or 12 patron box CBU (PVSC-TALL)*
- B. Parkview Cap and Pedestal for 13 or 16 patron box CBU (PVSC-SHRT)*

* CBU not included.

Standard Stucco Colors



Sandstone



Black



Bronze

CLUSTER BOX UNITS

USPS Approved F-Spec front loading Cluster Box Units (CBUs) offer centralized mail delivery with greatly enhanced security.

- Designed to meet or exceed newest USPS standards.
- CBUs are 30-1/2" wide, 62" high (installed) by 17-7/8" deep.
- CBUs have an outgoing mail compartment and parcel locker.
- Made of rust and rot proof aluminum and stainless steel.
- Pedestal included.

Products:

- C. CBU-8 Type I: 8 patron boxes (12" x 3-1/4" x 15"), outgoing mail compartment, and two parcel lockers 12" x 10" & 12" x 13".
- D. CBU-12 Type II: 12 patron boxes (12" x 3-1/4" x 15"), outgoing mail compartment, and a parcel locker 12" x 10".
- E. CBU-16 Type III: 16 patron boxes (12" x 3-1/4" x 15"), outgoing mail compartment, and two parcel lockers 12" x 10" & 12" x 13".
- F. CBU-13 Type IV: 13 patron boxes (12" x 5" x 15"), outgoing mail compartment, and a parcel locker 12" x 10".



A



B



B



C



D



E



F

Manchester Column Mounted Mailbox



MANCHESTER COLUMN MOUNTED MAILBOX

This decorative cast aluminum mailbox can be easily inset into a column, pilaster or wall. It features a tough powder coat finish in three different colors. Includes oversized masonry box that will hold seven days of mail. Match the Manchester® with an optional newspaper box or address plaque. Faceplate: 11-1/4" x 14-1/4" x 1-1/2". Masonry box: 8-3/4" x 12" x 16".

Products:

- A. Manchester Plain (MAN-1400)
- B. Manchester Fleur-de-lis (MAN-1402)
- C. Manchester Scroll (MAN-1401)
- D. Manchester Pineapple (MAN-1405)
- E. Manchester Oak Tree (MAN-1404)
- F. Manchester Cross (MAN-1403)

Manchester® Finishes



Matching cast aluminum address plaque: 3" brass numbers. 11" x 6-1/2". (ADD-1410)



Newspaper box: aluminum frame with black masonry box. Frame: 11" x 9-1/4". Insert: 9" x 7" x 15-3/4". (NEW-1415)



Front Door



Chute



Rear Door

Built-in security insert: Chute drops your mail out of reach of unwanted hands. The mail drops down to a locking rear door for easy collection. The security insert is made of 16 gauge powder coated steel and includes a separate compartment for outgoing mail. The newspaper box is not available with this option. (MAN-LLCOL)

MANCHESTER® STUCCO COLUMN

Our stucco column comes ready to install over your 4" x 4" wood post. It has a styrofoam core with a ready-to-paint stucco exterior. As an option, we offer three paint choices: Sandstone, Burnt Tuscan, or Slate Gray. See website for full installation instructions. Dimensions: 24" x 24" x 60" (18" x 18" center column).

Three different coating options are available:

Single Coat: This is the standard finish included in the base price. It can be painted with any exterior grade paint.

Double Coat: Also ready to paint, the second layer of cement is thicker and stronger than the standard single coat and is better suited for high-traffic locations where there is a greater chance of surface impacts.

Smooth Cement Coat: Typically used for exterior applications, the surface appears like unpainted cast concrete and it may be faux finished or painted. (MAN-STUCOL)



Sandstone

Burnt Tuscan

Slate Gray



Manchester® Stucco Column.



Ready to install over your 4" x 4" wood post.

Lewiston Collection Street Sign Systems

LEWISTON COLLECTION STREET SIGN SYSTEMS

Our street signs are constructed entirely of aluminum and stainless steel (will not rust or rot). Cast aluminum sign frames for all residential traffic sign shapes can be bolted onto the pole. All signs are built to DOT specs which measure 7' from bottom of first sign to ground unless designated otherwise. Overall height is determined by configuration. Poles come in three lengths: 14' 6", 12', and 11'. Pole diameter is 3" OD. Black is the standard color for street sign poles. Custom pole colors available.

Street sign blades and frames are of cast aluminum. Raised letter blades are two sided in black, white or dark green. The raised letters and border come in black, gold, or reflective white. Custom colors available.

Products:

- A. LSGN-804-CUSTOM
- B. LSGN-804-18X24
- C. LSGN-804-30X30-BFORS-LOGO
- D. LSGN-804-30X30D
- E. Bayview Solar Lamp with Raised Letter Blade: Beveled glass panes, super-bright LEDs, 8-1/2" x 19" (LSGN-800-SL-RLB-B)

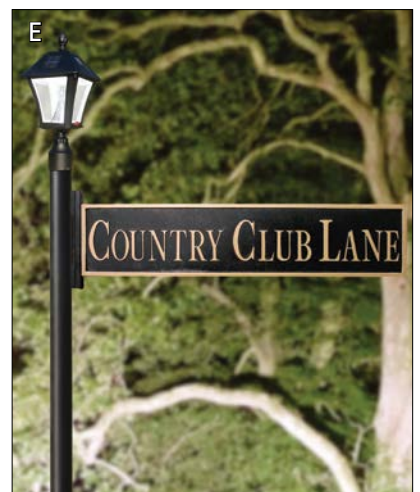
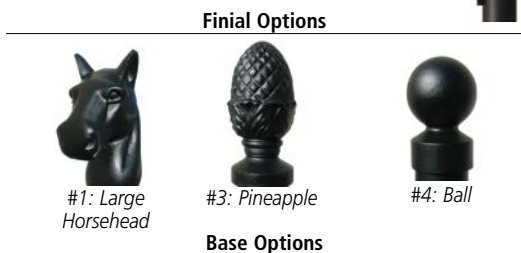
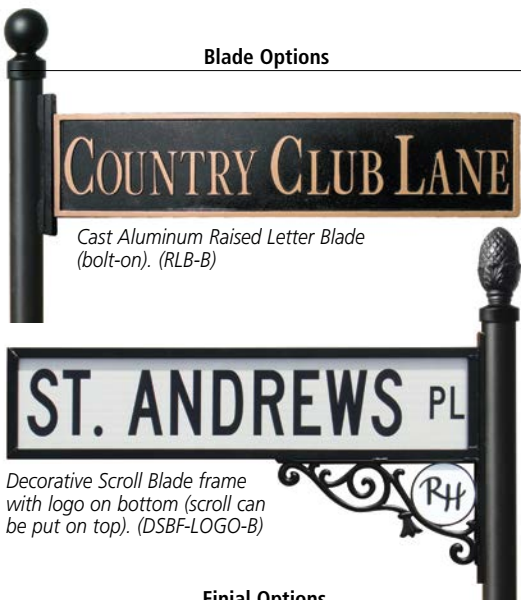
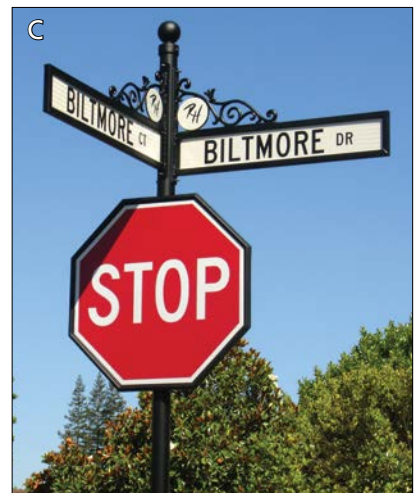

Lewiston Mailbox Collection



LEWISTON MAILBOX COLLECTION

Our Lewiston Collection is made from rust-free cast aluminum with a durable powder coat finish. Mix and match bases and finials to create a unique combination. For a finishing touch, add elegant cast aluminum address plates to the sides and front of the mailboxes. Builders and HOAs can personalize their address plates with a custom logo. Send us a sample of the logo for a free quote.

- Mailbox dimensions: 8-1/2" x 10" x 20"
- Optional address plates available.
- 3" OD direct burial pole height 5' 2"

Products:

- Cast Aluminum Mailbox: Shown in bronze with Ornate base and Pineapple finial. (LMC-703)
- Cast Aluminum Mailbox: Shown in white with Fluted base and Ball finial (LMC-804)
- Cast Aluminum Mailbox: Shown in black with Fluted base and Ball finial (LMC-804)
- Economy Mailbox: Shown in black with Fluted base and Ball finial. (LPST-1X-804-E1)
- Economy Mailboxes: Shown in black with Fluted base and Ball finial. Single, twin, triple and quad mounted mailboxes available. (LPST-4X-804-E1)
- Cast Aluminum Mailbox with Bayview Solar Lamp: Beveled glass panes, super-bright LEDs, 8-1/2" x 19" (LMC-800-SL)

Builders & HOAs, Personalize Your Mailboxes!

Your logo can be attached to the front and sides of our mailboxes. Fax us a sample of your design for a quote.



Mix & Match Bases & Finials



Mailbox Address Options

Our cast aluminum address plates are available in a wide range of color combinations. Please see our website for additional choices.



Bronze mailbox with antique bronze (gold numbers) side plate.



Bronze mailbox with dark brown (gold numbers) side plate.



Black mailbox with black (gold numbers) side plate.



White mailbox with white (gold numbers) side plate.



Economy vinyl address numbers available in gold, white or black.



Choose a cast aluminum front plate with fleur-de-lis or address.

Color Options



White



Black



Bronze

Finial Options



#1: Large Horsehead



#3: Pineapple



#4: Ball

Base Options



#7: Ornate



#8: Fluted

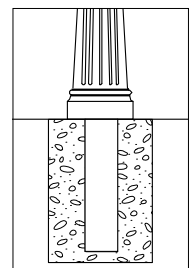

Direct In-ground Base Installation: Heavy-duty underground aluminum base extension won't rust or rot.

Provincial Collection Brass Mailboxes



PROVINCIAL COLLECTION BRASS MAILBOXES

Rustic handcrafted old world charm comes to life in the Provincial Collection. These elegant mailboxes are handcrafted one at a time from heavy gauge brass and copper in the old world tradition.

Products:

- A. MB400 (vertical) (8" W x 12-1/2" H x 3-1/2" D) (2.5 lb.)*
- B. MB500 (horizontal) (14" W x 8-1/2" H x 3-1/2" D) (3 lb.)*
- C. MB900 (roll top) (14-1/2" W x 10" H x 3-1/2" D) (4 lb.)*
- D. MB1000 (rural) (7-1/2" W x 8-1/2" H x 18" D) (6.5 lb.)**

* Optional magazine racks hang approximately 5".

** Add optional Lewiston post.

Finish Options



Polished brass



Antique hammered brass



Antique hammered copper

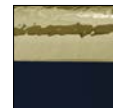

Antique hammered black bottom with hammered polished brass door

Note the brass mailboxes (polished, black bottom, or antique brass) have a lacquer finish to help protect them. The copper mailboxes do not have a lacquer finish and will form a natural patina over time.

Finish information: If you want a refined look, choose the polished brass finish. If you want a rustic look, choose the hammered finish. The rustic antique hammered finish is hand hammered, scuffed, and buffed. Please note that this finish may show some scuff (sanding) marks. This is part of the rustic character of this finish and is not a defect.

Finish protection: To help preserve the polished finishes, we recommend a clear, no-buff car wax. Clean the mailbox periodically with warm soapy water and a soft cloth, rinse and dry with a soft cloth. Then apply no-buff car wax. Polished brass finishes are not recommended for corrosive salt-air locations.



Handcrafted Old World Charm



Allux Series Mailboxes



ALLUX SERIES MAILBOXES

Products:

- A. Allux Grandform Mail/Parcel Box: Extra large parcel opening accepts large deliveries. Made from strong galvanized steel. Fitted with a heavy duty cam lock. Parcel opening: 11-7/8" x 5-3/8" x 14-1/2". Mailbox: 13-5/8" x 43-3/8" x 11". (ALX-GRP)
- B. Allux Mail/Parcel Box: Do you need more room? Our parcel mailboxes can easily hold two weeks of mail. Made from strong, galvanized steel and available in gray or black. Letter/parcel flap with soft closing mechanism: elegant and silent. Fitted with a heavy duty cam lock. Parcel opening: 4-1/2" x 11-7/8" x 13". (ALX-800: 15-3/8" x 37-3/4" x 11"), (ALX-810: 15-3/8" x 44-1/2" x 11").
- C. Allux 600: Top loading parcel mailbox is made from strong, powder coated steel. Available with standard cam lock. Parcel opening: 10-1/4" x 4" x 11". Mailbox: 15" x 41-3/8" x 9". (ALX-600)
- D. Allux Ellipse: Elegant, well designed mailbox which radiates elegance and quality. Its beautiful elliptical shape and convex black side panels give it a modern appearance. The mailbox has separate compartments for letters and magazines. The Ellipse is made from copper and powder coated steel and comes with a heavy duty cam lock. Slot: 12-1/4" x 1-1/2". Mailbox: 13-3/8" x 19-5/8" x 7-7/8". (ALX-ELI-CP)
- E. Allux 3000: Made from strong, galvanized steel which ensures that this mailbox will last for many years. The standard Allux 3000 model comes with a heavy duty cam lock. Black powder coated steel body available with copper or stainless steel accent door. Slot: 12" x 1-3/8". Mailbox: 12-1/4" x 18-1/2" x 6-1/4". (ALX-3000)
- F. Allux 7000: Elegant, well designed mailbox. Its beautiful elliptical shape gives it a modern appearance. The mailbox has separate compartments for letters and magazines. The Allux 7000 comes with a heavy duty cam lock. Available in stainless steel with black side panels. Slot: 11-1/2" x 1-1/8". Mailbox: 12-5/8" x 20" x 7-5/8". (ALX-7000)
- G. Allux LT150: Simple, locking mailbox is made from powder coated steel. Slot: 13-5/8" x 1-1/2". Mailbox: 15-3/8" x 13" x 5-7/8". (ALX-LT150)
- H. Allux Grandform: Stylish large capacity mailbox that comes with a heavy duty cam lock for extra security. The Grandform is made from black powder coated steel and features a matching or contrasting accent door. Available in black, stainless steel or copper. 13-9/16" x 17-5/16" x 7-7/8". (ALX-GF)
- I. Allux 100: Simple, top-loading, non-locking, wall mount mailbox. A top lid covers the 10-1/8" x 5-7/8" slot. Steel construction with durable powder coated finish available in black, white or red. 10-1/4" x 15-3/8" x 6-1/8". (ALX-100)
- J. Allux 200: Rich and roomy, top-loading, locking, wall mount mailbox. A top lid covers the 9-7/8" x 1-1/2" slot. Steel construction with durable powder coated finish available in black, white or red. 11" x 15-3/8" x 5-1/2". (ALX-200)



Accepts large parcels.



Direct Burial Mounting Base (MB-PL-BK)



Mailbox Stand: Select your stand in silver or black. Available with rods for casting in concrete to ensure good stability. Mailbox Stand fits most Allux mailboxes. Mailbox not included. 69-1/2" x 9-1/2", 1-1/2" diam. (STD-1007)

Elegant, Large Capacity Mailboxes



Dea's Garden Mailbox Collection



DEA'S GARDEN MAILBOX COLLECTION

- Mailboxes feature the look of rough stucco or smooth ceramic with the strength and durability of composite materials that are highly resistant to impact, lightweight and corrosion free.
- Finished with a highly protective coat of acrylic urethane paint to ease cleaning and maintain appearance.
- Mailbox doors are sealed against the weather.
- Easy to install, includes all mounting hardware.
- Optional post is available for most models.

Products:

- A. Pouch: Large mailbox with the look of smooth ceramic. Mount on wall or post. Orange (DSA-0101), Sand (DSA-0109), Beige (DSA-0106), White (DSA-0103).
- B. Stucco: Large mailbox with the look of stucco. Mount on wall or post. White: Off-white body with terracotta lid (DSA-0203), Cocoa: White body with dark brown lid (DSA-0220), Mild Brown: Bright brown body with dark brown lid (DSA-02A1).
- C. Ange: Large, locking mailbox with the look of smooth ceramic. Access door comes with a dial lock for added security. Antique White (DSA-2101), Ochre Brown (DSA-2103).
- D. Crea: Large, locking mailbox with the look of smooth ceramic. Access door comes with a dial lock for added security. Mail slot: 13-7/8" x 1-3/4". White (DSA-0703), Wither Black (DSA-07A1).
- E. Dune: Large, locking mailbox with the look of rough stucco. Access door comes with a dial lock for added security. White (DSA-0803), Wither Black (DSA-08A1), Mild Brown (DSA-08A2).
- F. Dune-U: Through-the-wall mailbox design with the look of rough stucco. Back panel comes with a dial lock for security. Mail slot: 13-3/4" x 1-1/4". Wither Black (DSA-1117), Mild Cream (DSA-1111).
- G. Bouquet: Large mailbox with the look of smooth ceramic. Mount on wall or post. Beige (DSA-0406).
- H. Collette: Large, locking mailbox that has the look of smooth ceramic with a wood grain trim. Access door comes with a dial lock for added security. Dark Ash (DSA-2002).



Orange (DSA-0101)

Sand (DSA-0109)

Beige (DSA-0106)



White (DSA-0103)

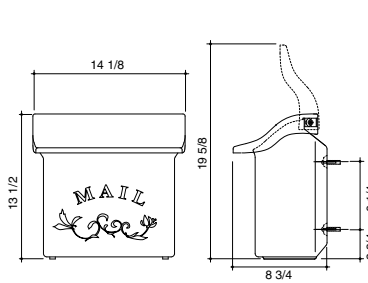
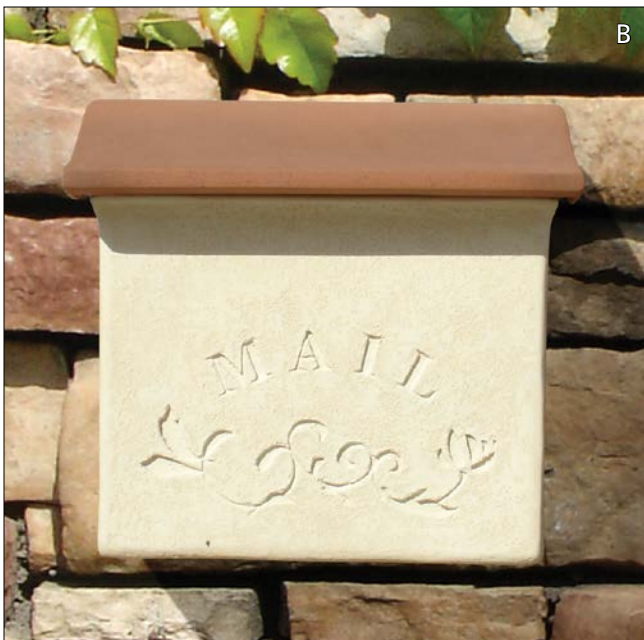
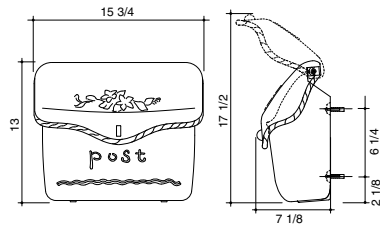

Mild Brown (DSA-02A1)



White (DSA-0203)



Cocoa (DSA-0220)

Lightweight & Durable Composite Materials

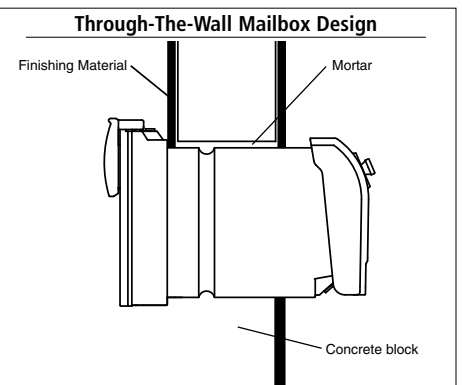
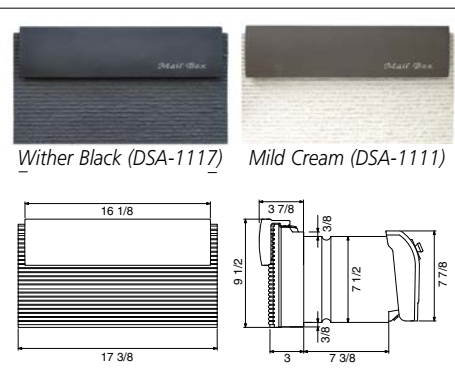
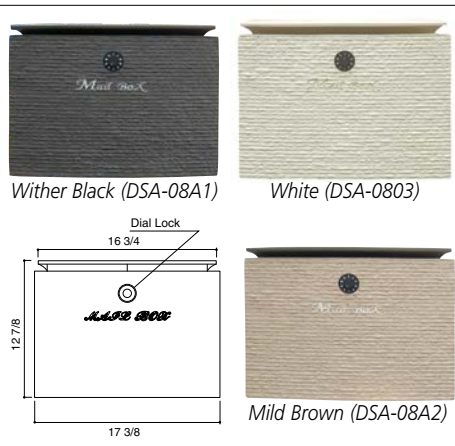
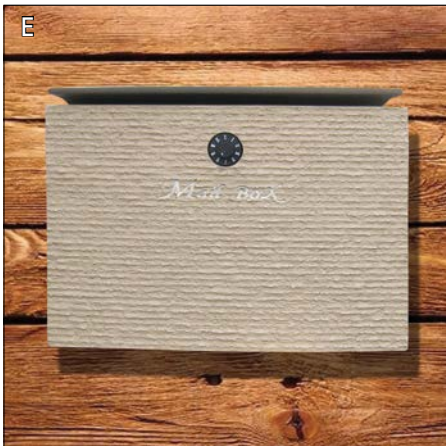
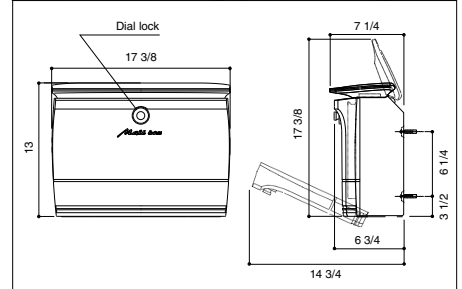
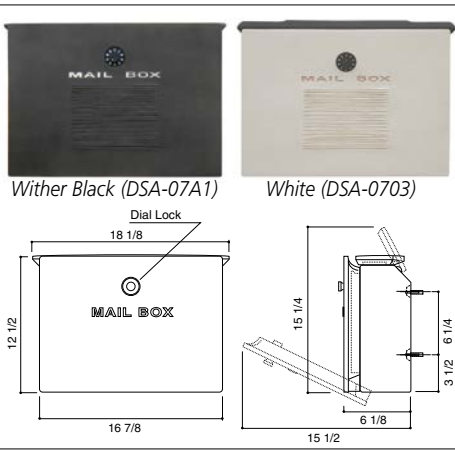
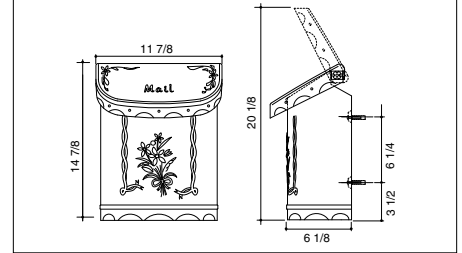
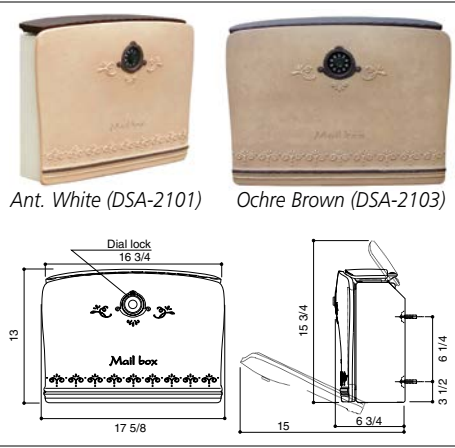

Edgewood Lighted Address Plaque



EDGEWOOD™ LIGHTED ADDRESS PLAQUE

- Cast aluminum frame won't rust or rot.
- Visible at over 100 feet away, day or night.
- Tough, high impact acrylic lens.
- Includes matching raised cast aluminum numbers.
- Low voltage, inexpensive to run.
- Easy to install, attaches to existing doorbell system.
- Patents #US D444,503 and #US D461,847.

Products:

- A. The Misty Oak, 13-3/4" x 9-1/2" x 2-3/4" (MIST-1309)
- B. Oval, 14-1/2" x 10-1/2" x 2" (LTO-1302)
- C. Standard, 13-1/2" x 7-1/2" x 2-1/2" (LTS-1300)
- D. Large, 13-3/4" x 8-7/8" x 2-1/2" (LTL-1301)
- E. Vertical, 7-3/4" x 17-1/2" x 2-1/2" (LTV-1303)

Edgewood™ Frame Finishes

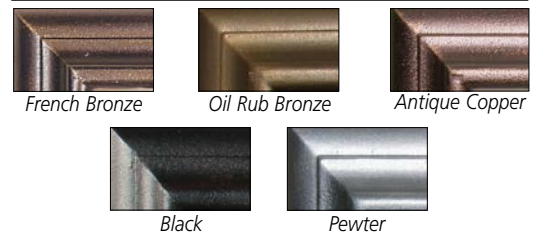

Transformers



Edgewood Classic Lighted Address Plaque



EDGEWOOD™ CLASSIC LIGHTED ADDRESS PLAQUE

- Black, weather resistant, high-impact polymer frame.
- Deep beveled frame with rich textured surface.
- Visible at over 100 feet away, day or night.
- Easy to install, attaches to existing doorbell system.
- Raised numbers and mounting hardware included.
- Inexpensive to run (low voltage 12/18V).
- Patent #US D444,503.
- Dimensions: 13-3/4" x 8-7/8" x 2-1/4"
- Model number: LTP-1304

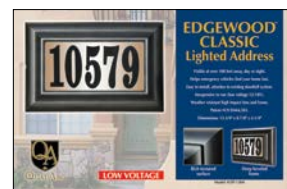

Attractive retail box.



Deep beveled frame.

Bayside Estate Lighted Address Plaque

BAYSIDE™ ESTATE LIGHTED ADDRESS PLAQUE

- Black powder coat finish will match any exterior décor.
- Cast aluminum frame won't rust or rot.
- Visible at over 100 feet away, day or night.
- Tough, high impact acrylic lens.
- Includes mounting hardware and up to five 6" vinyl numbers.
- Low voltage, inexpensive to run.
- Easy to install, attaches to existing doorbell system.
- Dimensions: 13-1/2" x 8-1/2" x 2-1/2"
- Model number: LT6B-1310



RidgeStone Address Plaque System

RIDGESTONE® ADDRESS PLAQUE SYSTEM

- Made with real crushed stone and resin.
- Rich stone textured background with polished border.
- UV and weather resistant, with color throughout material.
- Stone colors: Sandstone or Slate (gray).
- Easy to install, includes: plaque, 4" raised polymer numbers (two each, 0-9), mounting hardware, number layout template.

Products:

- A. Serpentine, 12-7/8" x 7-3/4" (RIG-4913SS), (RIG-4916SL)
- B. Oval, 13-1/4" x 7-1/8" (RIG-4911SS), (RIG-4914SL)
- C. Rectangle, 13-1/2" x 7" (RIG-4912SS), (RIG-4915SL)

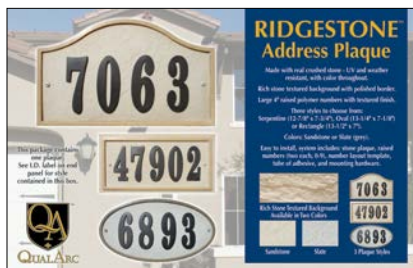

Attractive retail box.



Quick Ship Address Plaques

QUICK SHIP ADDRESS PLAQUES

- Made of cast aluminum (including numbers).
- Ship in 2-3 days.
- 4" numbers, up to 5 digits.
- Colors: Black/Gold, Bronze/Gold. Custom colors available for large orders.

Products:

- A. Waterford Rectangle, 13" x 6" (WATR-REC)
- B. Claremont Oval, 15" x 7" (CLAR-OVL)



Granite Address Plaques



GRANITE ADDRESS PLAQUES

- Made of solid granite with natural stone texture.
- Deeply engraved numbers. Single line: 4" numbers. Double line: 3" numbers and 1.25" letters.
- Four styles to choose from.
- Many granite colors available.
- Custom lettering available.
- Number colors: Black, White, Mocha, Gold.
- Optional aluminum lawn stakes: 1" wide by 18" long, black.

Products:

- A. Ridgecrest Arch, 15" x 7-3/4" (RID-4703)
- B. Executive Rectangle, 13" x 7" (EXE-4702)
- C. Rockport Oval, 15" x 7" (ROC-4701)
- D. Wexford Vertical, 4" x 19" (WEX-4719)
- E. StoneMetal Rectangle with Fleur-de-lis cast aluminum emblem mounted in engraved silhouette, 13" x 7" (EXE-4702-AL-FD)*
- F. StoneMetal Rectangle with Oak Tree cast aluminum emblem mounted in engraved silhouette, 13" x 7" (EXE-4702-BP-OK)*
- G. Scroll Frame: Cast aluminum with baked enamel finish, 18-3/4" x 12-7/8" (SCRL-4725)**

* Available in Autumn Leaf Natural or Black Polished.

** Scroll Frame colors: Black, White, French Bronze, Swedish Iron.



Granite store display.

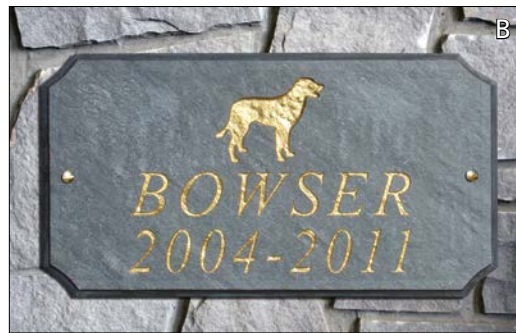

Rich Natural Stone Textures



Granite Number Colors



Black



White



Mocha



Gold



Granite Colors



Autumn Leaf
Natural



Black
Polished

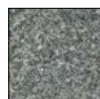

Black
Natural



Black Slate



Emerald Green
Polished



Five Color
Natural



Quartzite
(color varies)



Sand Granite
Polished



Sand Granite
Natural



White Granite
Natural

Granite Desk & Door Plaques

GRANITE DESK & DOOR PLAQUES

- Made with solid granite with deeply engraved letters.

Products:

A. Desk Name Plaques, 11-3/4" x 2-7/8" x 2" x 2" (DESK-6001)

B. Door Plaques, 11-3/4" x 3-3/4" x 3/8" (DOOR-6101)



Crushed Stone Address Plaques

CRUSHED STONE ADDRESS PLAQUES

- Made with real crushed stone and resin.
- Rich stone textured background with polished border.
- UV and weather resistant, with color throughout material.
- Deeply engraved numbers. Single line: 4" numbers. Double line: 3" numbers and 1.25" letters.
- Five styles to choose from.
- Stone colors: Sandstone or Slate (gray).
- Number colors: Black, White, Mocha.
- Optional aluminum lawn stakes: 1" wide by 18" long, black.

Products:

A. Knollbrook Vertical, 3-1/4" x 19" (KNO-4619)

B. Verona Serpentine, 15" x 9-1/2" (VER-4603)

C. Oakfield Oval, 14" x 10" (OAK-4605)

D. Riviera Arch, 15" x 9" (RIV-4602)

E. Chesterfield Rectangle, 15" x 7-1/2" (CHS-4601)

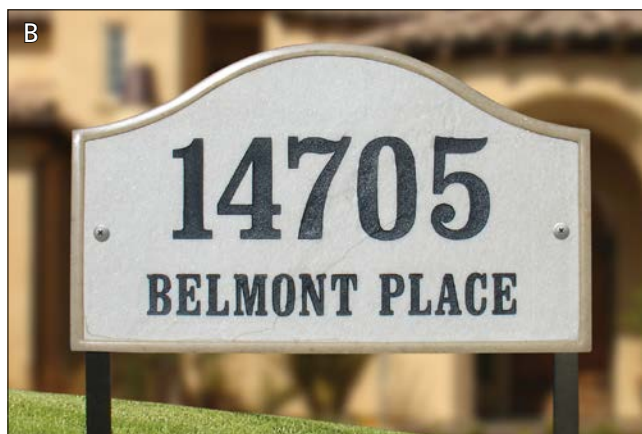

ParcelChest Secure Delivery Boxes

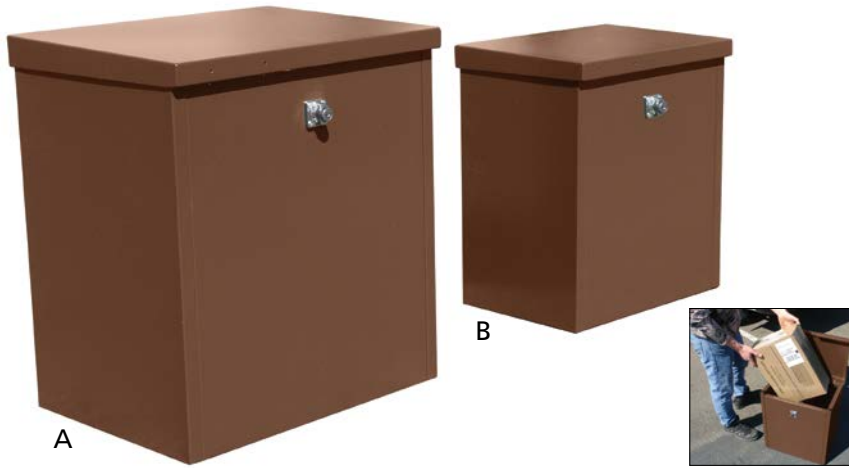

PARCELCHEST SECURE DELIVERY BOXES

Never miss another parcel delivery! Our secure home parcel boxes are designed to accept large packages and keep them safe until you get home. Using the box is very simple, just leave the door closed, but unlocked, and any delivery person can place a package into it and lock it.

- Built from thick, heavy gauge galvanized steel.
- Weatherproof, sealed against the weather.
- Lift-up lid for easy access.
- Mounting bolt kit included.
- Simple delivery instructions printed on parcel box.

Products:

A. Large: 26" x 25" x 19" (PCSDDB-LG)

B. Medium: 17" x 19" x 13" (PCSDDB-MD)

Equestrian Collection Mailboxes & Plaques



EQUESTRIAN COLLECTION MAILBOXES & PLAQUES

Our Equestrian Collection is made from durable, rust-free aluminum with weather resistant finishes to last a lifetime. Mix and match bases and finials to create a unique combination.

Products:

A. Cast Aluminum Mailbox: Shown with Fluted base and Large Horsehead finial. Mailbox 8-1/2" x 10" x 20" (shown with optional address plaques). 3" OD direct burial pole height 5' 2". (MBX5-801)

B. Large Hanging Ranch Sign: Shown with Large Horsehead finial. Sign 15-1/2" x 10-1/4". Pole height 5' 4". (SNPST-701)

C. Saddle Rack: (SDLRCK-HRS1: Single, 28-1/2" x 22" x 11"), (SDLRCK-HRS3: Triple, 28-1/2" x 72" x 11")

D. Scroll Mount Address Post: Shown with Ornate base and Large Horsehead finial. Plaque 13" x 6" (4" #'s). Scroll 16" x 14". Pole height 4' 6". (ADPST-701)

Finial Options



#1: Large Horsehead



#3: Pineapple



#4: Ball

Base Options



#7: Ornate



#8: Fluted

Post Color Options



White

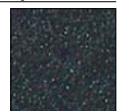

Black



Bronze

